

Experience  
Change



## Committed to You. Committed to Nature

*Committed to Service. At Videocon, service commitment is of utmost priority, which is why our dedication goes beyond the conventional. For us, service is not just about keeping products at their operational best, but also the beginning of a binding relationship. With more than 350 customer care points spread across the country to address your needs, we are just a call away. Our endeavour is to offer a bigger cause by keeping our products Eco-Fit.*

### VIDEOCON INDUSTRIES LIMITED

**Reg. Office:** Videocon Industries Ltd., 14 kms. Stone, Aurangabad-Paithan Road, Chitegaon, Tq, Paithan, Dist. Aurangabad-431 105 (India). Phone No.: 02341-251501/02/03/04

**Corporate Office:** Plot No. 248, Udyog Vihar, Phase - 4, Gurgaon - 122015, Phone No.: 0124-4215400

For more details visit us at [www.videoconworld.com](http://www.videoconworld.com). For online shopping visit us at [www.edigiworld.com](http://www.edigiworld.com). You could write to us at [marketing@vgmail.in](mailto:marketing@vgmail.in). For service issues write to us at [customer care@vgmail.in](mailto:customer care@vgmail.in) or SMS SVC to 53030

CODE NO:XXX-X-XXXX-XXX-XX-

Experience  
Change



## Owner's manual

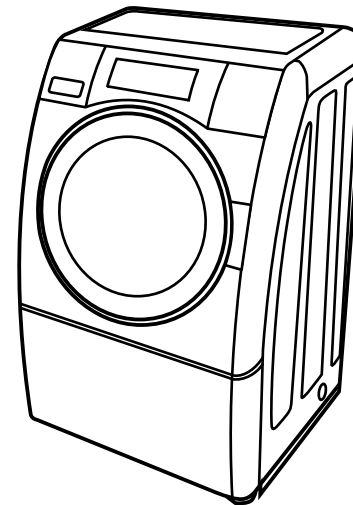

**MODEL: WM VF62CAWH-CSN**

**CAREEN**

### FULLY AUTOMATIC WASHING MACHINE

*Please read this instruction manual carefully before operating your machine. Retain it for future reference. Record model name & serial number of the machine. Please quote this information when you require service.*

# CONTENTS

SAFETY NOTICE.....	2
WARNINGS.....	2
NAME OF PARTS .....	3
ACCESSORIES .....	3
LOCK AND UNLOCK THE DOOR.....	4
USAGE INSTRUCTION FOR DETERGENT CASE .....	4
NAMES AND FUNCTIONS OF CONTROL PANEL .....	5-6
NORMAL USAGE .....	7
HOW TO USE THE CUSTOM PROGRAM .....	8
HOW TO USE THE DELICATE PROGRAM .....	9
HOW TO USE THE BLANKET PROGRAM .....	10
HOW TO USE THE PRESET PROGRAM .....	11
VARIOUS FUNCTIONS .....	12
CHILD LOCK FUNCTION .....	12
ADD CLOTHES DURING THE OPERATION .....	12
HOW TO DELETE THE END BUZZER .....	12
PROGRAM CHOOSING GUIDE .....	13
CARE AND MAINTENANCE .....	14
NO TROUBLE CONDITIONS .....	15
TROUBLE SHOOTING GUIDE .....	16
INSTALLATION INSTRUCTIONS .....	17-19
WASHING TIPS .....	20
WARNING .....	21
SPECIFICATIONS .....	21
AUTHORISED SERVICE CENTERS .....	22
WARRANTY TERMS AND CONDITIONS .....	23-24

# SAFETY NOTICE (be sure to observe)

- To protect the user and other people's health and property, be sure to observe the following safety notice.

## WARNINGS

### ● Possible danger of electric shock.

1. Use special-purpose socket with rated current of washer and with fine ground connection.
2. Hold firmly the plug when plug in and pull out it. Don't use the damaged electrical cord. Use dry cloth to clean the plug when it is dirty.
3. Do not use wet hands to insert or pull out the plug.
4. Pull out the plug when the machine is after operation, under repair or in cleaning.

### ● Possible danger of fire or electricity leak.

1. Do not let the washer near fire, or put lighted cigarettes , candle , and other volatile materials on the machine.
2. Do not pour water over the panel.
3. Do not put the washing machine in very wet places or water dripping places.
4. Check the drain hose is placed correctly, so that water drain out smoothly..

### ● Possible danger of burn caused by high temperature.

1. The glass door becomes hot in process of high-temperature washing. Do not touch the door when machine is on, especially children.
2. Keep kids and pets far away from the machine during operation.
3. If you need to open the door during high-temperature washing , wait until the temperature drop to safe standard, and the door unlocked automatically.

### ● Possible danger of body injure.

1. Packing material may be dangerous to kids, please keep all packing material (plastic bag foam etc) far away from the kids.
2. This machine is not intended for use by persons (including kids) with reduced physical, sensory or metal capabilities, or lack of experience and knowledge, unless they have been given supervision or instruction concerning use of the machine by a person responsible for their safety.
3. Kids are forbidden to play with the washing machine. Keep pets far away from washing machine.

### ● Possible danger of washing machine damage.

1. Do not put heavy things on the washing machine.
2. Two people are required in moving or transportation.
3. Water temperature could not exceed 60°C in the washing process.
4. Only professional serviceman could repair or remold the washing machine.

### ● Possible danger of clothes damage.

1. Do not wash waterproof clothes, for example: raincoat, feather goods, sleeping bag, etc.
2. Your washing machine is only for home use and is only designed for the textiles suitable for machine washing.

### ● Possible danger of explosion.

1. Do not wash flammable clothes stained with kerosene, gasoline, thinner, etc.
2. Do not operate the machine when there is gas leak.

## NAME OF PARTS

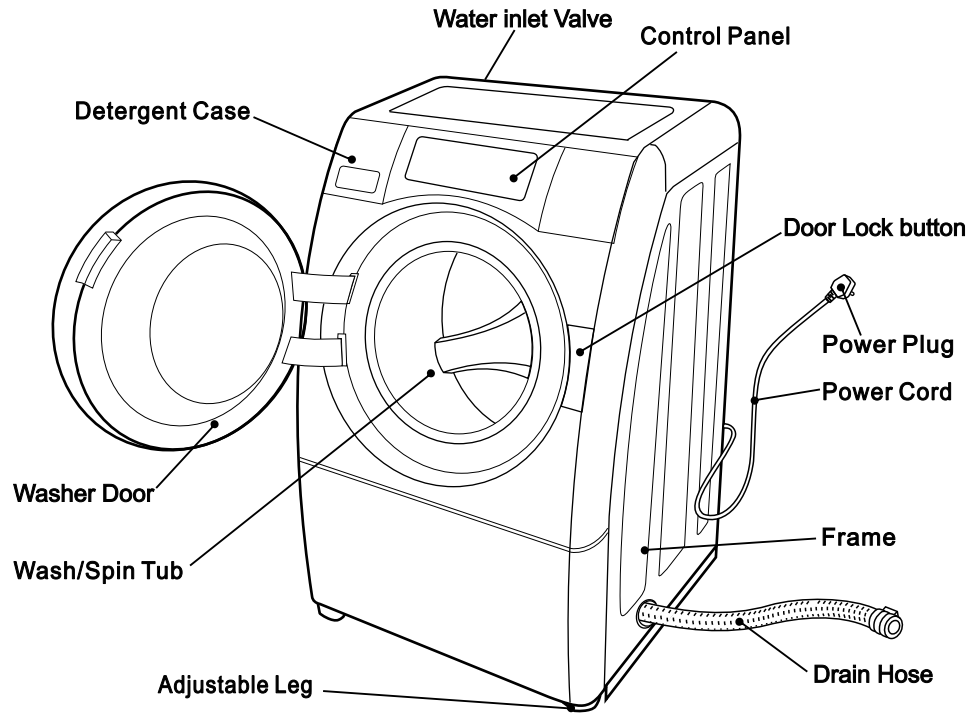

## LOCK AND UNLOCK THE DOOR

### Lock the door

The door will be locked automatically when the machine gets started, and the (lock) light will on at the time.

### Unlock the door

When the (lock) light is on, press START/PAUSE button, the Wash/Spin tub stop, then you will hear a “clicking” sound, which means the door has unlocked.

- The door will not open if you directly pulled out the electrical plug.
- If there is a power failure during the operation, wait for power on, press POWER ON/ OFF button, door will be unlocked automatically.
- Foam spill over if you open the door during washing process, use towel to clean it.

## USAGE INSTRUCTION FOR DETERGENT CASE

### Liquid detergent and Bleach

- Use low bubble liquid synthetic detergents.
- For the concentrated liquid detergents, diluted it double times with water, then pour into the case.

### Powder synthetic detergents

- For the undissolved detergents, for example: powder state soap, dissolve it in advance, then pour into the case.

### Softener

- Put into the case before washing, it will be poured into the tub automatically at the last round of rinse.
- For the concentrated detergents, use corresponding proportion of water to dilute it, then pour it into the case.
- No exceed to the full mark line.

- High bubble Washer powder or detergent is forbidden.
- Use the detergents in accordance with the instruction by its manufacturer.
- Excessive detergents will cause too much bubble and affect the rinse, also create function faults.
- Choose suitable detergents in accordance with the type and color of clothes, the water temperature and the stain.

## ACCESSORIES

Instruction manual	Water Supply Hose	Tap Adaptor	Spanner	Lid	Drain Hose	Ratmesh Screw

# NAMES AND FUNCTIONS OF CONTROL PANEL

## NUMERAL INDICATION

- Indicating water temperature, wash time, rinse times, spin time and spin speed after power switching on.
- Indicating the remained time during operating. For example, remaining time is 18 minutes.
- Indicating trouble code when work abnormally.  
For example, no water inletting

18

E11

## POWER ON/OFF button

- Press this button to turn on/off the electrical power.
- 12 seconds after the end of a program, power off automatically.

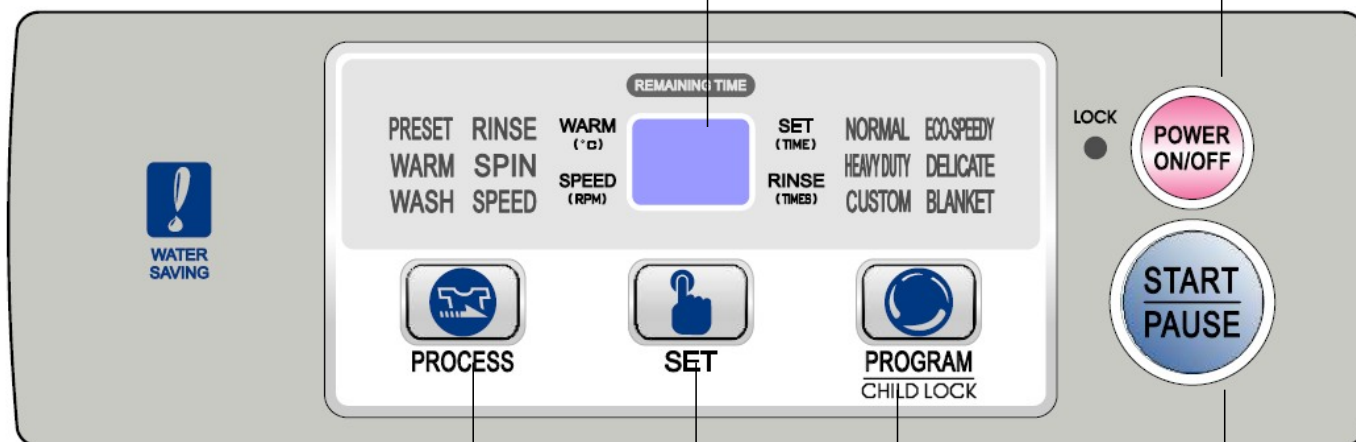

## PROCESS and SET button

You can set the preset, warm, wash time, rinse times, spin time and spin speed by PROCESS and SET button freely according to your need.

For example: set preset time

- Press the PROCESS button till the preset light on, and Press the SET button to select your need time.

## PROGRAM button

- Choose the right program according to the type and stain of clothes.
- The light will be on after certain program be chosen.
- Press the PROGRAM button for sec to activate CHILD LOCK

## START/PAUSE button

- Press the button and start work.
- Press the button in the course of any program, the machine suspend work, re-press the key and the program goes on, execute the rest order.
- Press the button in operation of the machine, door will be unlocked.

## NORMAL USAGE

### 1.Preparation:

- Load the laundry into the washer. Close the washer door.
- Put the detergent and softener into the Detergent Case.
- Connect the Drain Hose. Connect the Water Supply Hose to the faucet and turn the faucet on. Plug the Power Cord into a socket-outlet.

2.Press the  button to turn the power on.

3.Press the  button continuously and choose the NORMAL, HEAVY DUTY, CUSTOM, ECO-SPEEDY, DELICATE, BLANKET course.

4.Press the  button, the washer will start the washer operation.

5.At the end of operation, the buzzer will sound and the power will be turned off automatically after 12 seconds.

- Wash and Spin capacity below 2.0 kg in “DELICATE” course.
- Wash and Spin capacity below 2.0 kg in the “ECO-SPEEDY” course.

## HOW TO USE THE CUSTOM PROGRAM



You can set wash time, water temperature, rinse times, spin time, rotate speed and adjust operating time freely according to your habit or laundry.

### 1.Preparation:

- Load the laundry into the washer. Close the washer door.
- Put the detergent and softener into the Detergent Case.
- Connect the Drain Hose. Connect the Water Supply Hose to the faucet and turn the faucet on. Plug the Power Cord into a socket-outlet.

2.Press the  button to turn the power on.

3.Press the  button to select the CUSTOM course

4.Press  ,  button to set preset, warm, wash time, rinse times, spin time, water temperature and rotate speed.

5.Press the  button, the washer will start the washer operation.

6.At the end of operation, the buzzer will sound and the power will be turned off automatically after 12 seconds.

## HOW TO USE THE DELICATE PROGRAM

For washing delicate and synthetic fiber clothes. They shall be washed as required in the labels.

### 1.Preparation:

- Load the laundry into the washer. Close the washer door.
- Put the detergent and softener into the Detergent Case.
- Connect the Drain Hose. Connect the Water Supply Hose to the faucet and turn the faucet on. Plug the Power Cord into a socket-outlet.

2.Press the  button to turn the power on.

3.Press the  button to select the DELICATE course

4.Press the  button, the washer will start the washer operation.

5.At the end of operation, the buzzer will sound and the power will be turned off automatically after 12 seconds.

- Wash capacity below 2.0kg.
- Take out the clothes promptly when program ends, and hung to dry the clothes, in case the clothes become deformed.
- No wash preset.
- Water temperature should not exceed 30°C to prevent clothes.
- Wash the white or bight-colored clothes separately from the dark-colored clothes.
- Use detergent for wool to relieve damage of clothes, and improve the wash effect.

## HOW TO USE THE BLANKET PROGRAM

For washing blanket and other bulky items.

1.Fold the blanket

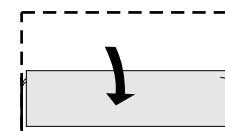

Fold in two by the short side

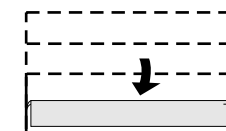

Fold once again in the same direction

2.put blanket into the wash/spin tub.

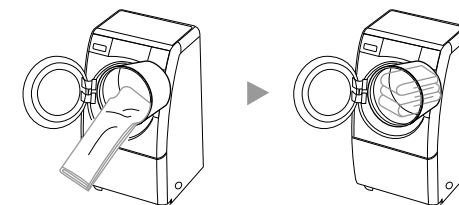

### 3.Preparation:

- Close the washer door.
- Put the detergent into the Detergent Case.
- Connect the Drain Hose. Connect the Water Supply Hose to the faucet and turn the faucet on. Plug the Power Cord into a socket-outlet.

4.Press the  button to turn the power on.

5.Press the  button to select the BLANKET program.

6.Press the  button, the washer will start the washer operation.

7.At the end of operation, the buzzer will sound and the power will be turned off automatically after 12 seconds.

- Do not use net bag for the machine washable blanket, otherwise the washer vibrate abnormally and will be damaged in the spin process.
- Do not tweak or roll clothes into a boll before put them into the tub.
- Electric blanket and carpet are forbidden of wash.
- 100% villous and the long-villous blanket are forbidden of wash.
- Wash capacity of 100% chemical fiber below 3.0kg.
- Wash capacity of 100% cotton blanket below 2.0kg.
- Water temperature should not exceed 30°C.

## HOW TO USE THE PRESET PROGRAM



The preset time means the ending time of washing.

### 1.Preparation:

- Load the laundry into the washer. Close the washer door.
- Put the detergent and softener into the Detergent Case.
- Connect the Drain Hose. Connect the Water Supply Hose to the faucet and turn the faucet on. Plug the Power Cord into a socket-outlet.

2.Press the  button to turn the power on.

3.Press the  button to select the desired program.

4.Press  button till preset, water temperature, wash time, rinse times, spin time and rotate speed light on. And press  button to set time.

5.Press the  button, the washer will start the washer operation.

6.At the end of operation, the buzzer will sound and the power will be turned off automatically after 12 seconds.

- PRESET function could not be used for DELICATE course.
- To change the preset time, please press POWER ON/OFF button, restart from step 2.
- To cancel the preset, press POWER ON/OFF to shut off the electrical power.
- To check the preset procedure, press PROGRAM button, the washer will show you the current preset setting for 5 seconds.
- The actual ending time maybe different from the preset time as the different of water pressure, drainage, type of clothes, water temperatures, etc.
- After the preset is started, the corresponding light will be turn on.

## VARIOUS FUNCTIONS

### CHILD LOCK FUNCTION

Child lock can be set to prevent children from getting into the tub. The door will be locked either in working or power off.

#### Method of setting:

After pressing POWER ON/OFF button to power on, press PROGRAM button for over 4 seconds, until a sound from buzzer. Follow the same instruction listed above the unlock door.

### ADD CLOTHES DURING THE OPERATION

Used for washing things add during operation.

#### Operation method:

press START/PAUSE button, doorlock light flashes and turns off, the door is unlocked. Then open the door, add clothes into the tub, close the door, press START/PAUSE button, program will continue.

### HOW TO DELETE THE END BUZZER

If select this function, the buzzer will not sound after the end of operation.

#### Method of setting:

Press the POWER ON/OFF button and hold down the START/PAUSE button for 4 seconds until a sound from buzzer. Follow the above instruction to restart buzzer.

## PROGRAM CHOOSING GUIDE

COURSE	WASH CAPACITY (kg)	WATER TEMPERATURE (°C)	WASHING TIME(min.)	RINSE TIMES	SPINNING TIME(min.)	SPINNING SPEED (rpm)	TOTAL TIME(min.)
NORMAL	6.2	30 <small>(Cold water, 20~80)</small>	30 <small>(5~60)</small>	2 <small>(1~4)</small>	6 <small>(1~9)</small>	700 <small>(500~Max.)</small>	approx. 69 min.
HEAVY DUTY	6.2	30 <small>(Cold water, 20~80)</small>	50 <small>(5~60)</small>	3 <small>(1~4)</small>	9 <small>(1~9)</small>	700 <small>(500~Max.)</small>	approx. 105 min.
CUSTOM	6.2	30 <small>(Cold water, 20~80)</small>	30 <small>(5~60)</small>	2 <small>(1~4)</small>	6 <small>(1~9)</small>	700 <small>(500~Max.)</small>	approx. 69 min.
ECO-SPEEDY	2.0	—	10 <small>(5~40)</small>	1 <small>(1~4)</small>	3 <small>(1~9)</small>	700 <small>(500~900)</small>	approx. 33 min.
DELICATE	2.0	— <small>(Cold water, 20~30)</small>	20 <small>(5~40)</small>	3 <small>(1~4)</small>	3 <small>(1~3)</small>	500	approx. 69 min.
BLANKET	3.0	— <small>(Cold water, 20~30)</small>	20 <small>(5~40)</small>	3 <small>(1~4)</small>	6 <small>(1~6)</small>	700 <small>(500~900)</small>	approx. 72 min.

### NOTES

1. Washing time changes in different water pressure, drain situation, clothes texture, weight, temperature, etc.
2. The needed washing displayed during operation could be different from the actual time needed.
3. As the quantity of clothes and detergents type are different, rinse result maybe not ideal if the spin speed is slow. In this case, add the rinse times.
4. Parameter in the above chart will be different as the machine types are different.

## CARE AND MAINTENANCE

- Washing machine should be kept in good maintenance during long time of use. Good using habit could extend its working life.
- Pull out the plug when in maintenance, in case of electricity danger.

### Washer body

- Wipe the machine body with soft clean cloth. Dip the cloth into detergents or liquid soap and then clean the machine body when there is heavy dirt on it.
- Do not pour water directly on the machine.
- Do not clean the machine body with scouring powder, diluents, gasoline, alcohol, and other chemical things.

### Sealing washer of the door

Wipe the dirt and fabric scrap away by towel every time after use. If there are things like pin in the groove of the sealing washer, make sure to fetch them out.

### Clean Tap Adaptor filter (suggest clean it every 6 months)

1. Pull the water inlet hose out.
2. Turn off the revolver according to below photo.

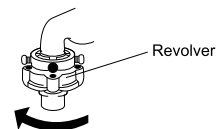

3. Load the Tap Adaptor filter and clean the dirt with a toothbrush.

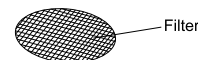

4. Install the clean Tap Adaptor to resolver and water inlet hose.

### Clean the water inlet Valve (Suggest clean it every 6 months)

1. Detach the Water Supply Hose from the Water Inlet.
2. Take out the metal filter from the water inlet valve.
3. Clean the metal filter of Water Inlet with a toothbrush etc, then assemble the metal filter in the valve.

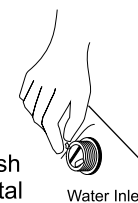

4. Connect the Water Supply Hose.

### Clean methods of the detergents case

- Clean the detergents case regularly in case that detergents remained in the box get mildew.
- Pull out while lift the box to carry it out, clean it by water and restore it.

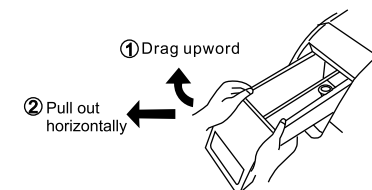



## NO TROUBLE CONDITIONS

SITUATION	REASON
The washer door can not be opened.	<ul style="list-style-type: none"> <li>• The washer is in operation</li> <li>• Set by the child lock</li> <li>• There is clothes caught between the seal ring and the door.</li> </ul>
Peculiar smell.	<ul style="list-style-type: none"> <li>• Some components are made by rubber, so there may be smell of rubber.</li> </ul>
Little water in wash and spin	<ul style="list-style-type: none"> <li>• Drum washing machine need only little water to wash clothes.</li> </ul>
No water inflow.	<ul style="list-style-type: none"> <li>• Weather the faucet is open.</li> <li>• Weather the Water Supply Hose be frozen.</li> <li>• Weather the Water Supply Hose or the metal filter in water inlet be blocked.</li> </ul>
Inflow of water during operation.	<ul style="list-style-type: none"> <li>• Water will be supplied automatically when the water level decline.</li> <li>• Add clothes during operation.</li> </ul>
Discharge water in washing clothes	<ul style="list-style-type: none"> <li>• Weather or not there is too much detergents, or detergents with too much bubble.</li> </ul>
Remaining time changes	<ul style="list-style-type: none"> <li>• If the washing clothes is in uneven distributed, water will be added to balance it.</li> <li>• The displayed remaining time is calculated on the basis of 15 liter/minute water intake. As the water pressure will change, actual time will be prolonged or shortened accordingly.</li> <li>• If clothes are biased in spin, the spin time will be prolonged to correct the biasing.</li> </ul>
Abnormal sound in spin process.	<ul style="list-style-type: none"> <li>• weather or not the electricity wire contact the machine body.</li> <li>• weather the bolt used to fix machine during transportation be dismantled.</li> <li>• weather there are hairpin, coin, etc in the roller.</li> </ul>
Program stops when power off	<ul style="list-style-type: none"> <li>• If power off , the program stop and will not continue when power on, please press the POWER ON/OFF button and reset the program.</li> </ul>

## TROUBLE SHOOTING GUIDE

Trouble Indication	Kind Of Trouble	Where To Check	How to resolve the problem
	The washer does not work at all.	<ul style="list-style-type: none"> <li>• Check if the Power Cord is securely plugged in.</li> <li>• Press the POWER ON/OFF button.</li> <li>• Press the START/PAUSE button.</li> <li>• Press the PRESET button.</li> <li>• Check whether power failure occurs.</li> <li>• Check whether the fuse or circuit breaker has been activated.</li> </ul>	
E11	Water does not flow into the Wash/ Spin Tub or water flow is slim.	<ul style="list-style-type: none"> <li>• Whether the faucet be opened.</li> <li>• Whether the Water Supply Hose be frozen.</li> <li>• Whether the Water Supply Hose or the metal filter in water inlet be blocked.</li> <li>• Whether the water is out of supply.</li> </ul>	Check and resolve the problem ,then press START/PAUSE for one times to restart the washer.
E12	Water does not drain out.	<ul style="list-style-type: none"> <li>• Whether the outfall is too high.</li> <li>• Whether the Drain Hose is placed correctly.</li> <li>• Whether the Drain Hose is blocked by scrap of fiber.</li> <li>• Whether the Drain Hose is too long.</li> </ul>	Check and resolve the problem ,then press START/PAUSE for one times to restart the washer.
H	Failure of open the washer door.	<ul style="list-style-type: none"> <li>• Whether the temperature of water exceeded 40°C.</li> <li>• Whether the temperature of water in washing process exceeded 40°C.</li> </ul>	The door will open automatically as soon as the temperature below 40°C.
U3	Failure of spin	<ul style="list-style-type: none"> <li>• Whether the washing machine be posited steadily.</li> <li>• Whether the washing clothes is too big or too heavy.</li> <li>• Whether the pieces of clothes for spin is too few.</li> <li>• Whether the blanket be rolled into a ball.</li> </ul>	When the clothes is too little, add 2~3 pieces of clothes, then check the machine, Close the door, and press START/PAUSE button for one times to restart the machine.

# INSTALLATION INSTRUCTIONS

## Transportation

Two people are required in transportation. The washer should be kept upright, each person hold the bottom of one side to move the machine.

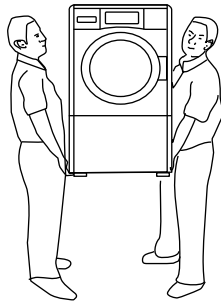

## Remove the bolt used to fix the machine in transportation

To protect the machine in transportation, there are two bolts inserted into the inner part of the machine. Remove these bolts before use. (otherwise there will be strong shock, noise, and disfunction in spin process.)

1. Unscrew the bolts that are fixed before transportation by spanner (two bolts)
2. Remove the bolts horizontally.
3. Fit the lid into the holes .

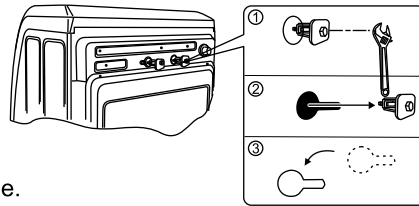

- Let the sales force or professional maintenance worker to install the machine.
- Keep the dismantled bolts carefully , you will need them in house moving.

**NOTE:**  
Detach the protection washer before use the machine.

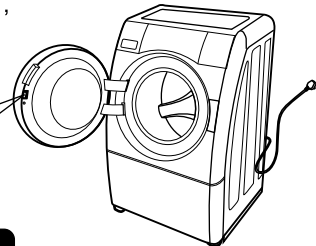

## Adjust the machine horizontally

There will be strong shock, noise, and disfunction in operation if the washing machine is not steadily installed. Please adjust the front two adjustable Leg.

**Methods are as follows:**

1. Check whether the washer is on a level surface using a plumb line as shown in the Beside figure.
  - The washer is on level ground floor if the Frame line of washer is parallel with the plumb line.
2. Adjust the Adjustable Leg of washer if necessary to make the washer level as shown in the Beside figure.
3. Put your hands on the washer diagonally, press and shake the washer slightly to make sure that the washer is steady.

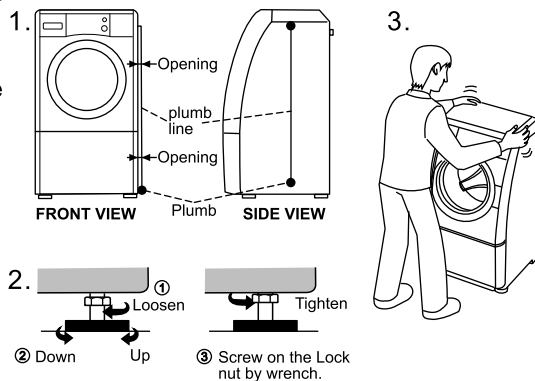

# INSTALLATION INSTRUCTIONS

## How to Attach the Tap Adaptor

1. Loosen the four screws and slide the top of the Tap Adaptor (Section A in the figure) onto the faucet. Then, securely tighten the four screws provided with the Tap Adaptor by using a screwdriver to secure the top of the joint to the faucet.
2. Remove the CAUTION label from the Tap Adaptor.
3. Turn the male coupler on the joint (section B in the figure) clockwise to attach it securely to the top of the joint (section A in the figure).

- The appliance is to be connected to the water mains using new Water Supply Hose and Tap Adaptor Joint and old hose-sets should not be reused.

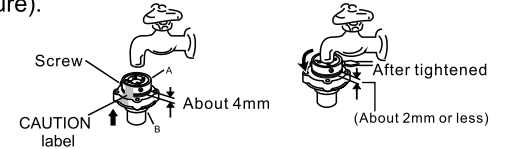

## CAUTION:

If outer diameter of faucet is larger than calibre of the Joint Ring, loosen the four screws and remove the Joint Ring from the Tap Adaptor.

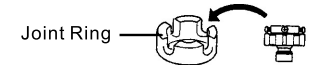

## Installing Water Supply Hose to the Washer

1. Turn the nut clockwise while holding the hose.
- Turn the nut counterclockwise after turning the faucet off when you want to detach the Water Supply Hose.

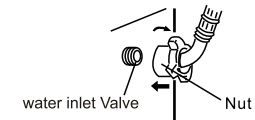

## Connecting the Water Supply Hose to the Tap Adaptor

1. While pushing the sleeve on the female coupler (section D in the figure) of the joint down with your fingers, connect the female coupler to the male coupler (section C in the figure).
2. Release the sleeve, then push the Water Supply Hose up into the Tap Adaptor until it clicks into place.
3. Pull the Water Supply Hose down to make sure that it is securely attached.

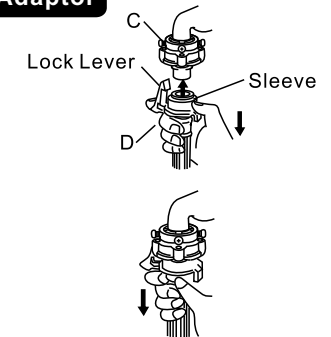

## How to Detach the Water Supply Hose

Please read the following procedure in order to avoid spilling water when detaching the Water Supply Hose.

1. Turn the faucet off.
2. Press the POWER ON/OFF button to turn the power on ,the NORMAL button and the START/PAUSE button.
3. Press the POWER ON/OFF button to turn the power off 15 seconds later.
4. While pushing the lock lever and the sleeve on the female (section D in the figure)of the joint down with your fingers, detach the female coupler from the male coupler (section C in the figure).

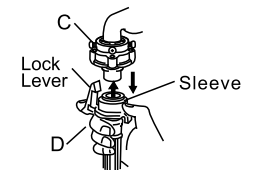

# INSTALLATION INSTRUCTIONS

## How To Install The Drain Hose

1. Install the Drain Hose to the Drain Outlet (as instructed on the photo), then fix it by Hose Band.
2. Place the other end of the hose to drain channel, keep suitable gap between hose crankle and drain channel for easier draining.

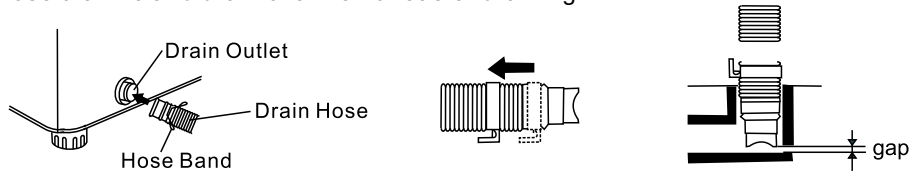

## Changing the Drain Hose Direction

- Drain direction left or right is optional.
- If drain direction change needed, please contact the nearest authorized service center or dealer. Refer to figure A (before change) and figure B (after change).

# WASHING TIPS

## Washing Tips

- Check whether there is anything in the pockets (for example: coin, pin, clip, paper, etc).
- Zips shall be zipped close and buttons or hooks shall be fixed. The loose band or ribbon shall be bound together.
- Do not wash colored clothes together.
- Follow the washing guide printed on the clothes' mark or the symbol types of care label by the manufacturer.
- Before first washing, use a white towel dipped in detergents to rub an uneasily discovered place of the clothes for a moment, check whether there is color on the white towel, if the color fade, be careful in washing the clothes.
- If a part of clothes is too dirty, use a towel or soft brush dipped in detergents to rub the dirty part slightly in a same direction. then put the clothes into machine.
- The machine may shock heavily in spin when there is only few clothes or single big and heavy dress, add 2~3 pieces of clothes into the tub to relieve shock.

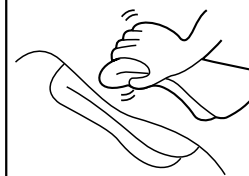

## WARNING - This appliance must be earthed.

### FOR WASHER PLUG TOP 3 PIN (For BS Standard Plug With A 13 Amp Fuse)

#### IMPORTANT

The wires in this mains lead are coloured in accordance with the following code:

Green/yellow: Earth      Light Blue: Neutral      Brown: Live

As the colours of the wires in the mains lead of this appliance may not correspond with the coloured markings identifying the terminals in your plug, proceed as follows:

- The wire which is coloured green and yellow must be connected to the terminal in the plug which is marked with the letter E or by the earth symbol  or coloured green or green and yellow.
- The wire which is coloured light blue must be connected to the terminal which is marked with the letter N or coloured white.
- The wire which is coloured brown must be connected to the terminal which is marked with the letter L or coloured black.
- Wipe the Power Plug with a soft cloth and remove any dust to prevent a risk of the accidental fire before plugging into the socket-outlet.
- To prevent electric shock, be sure to provide adequate electrical grounding for the washer.
- Do not plug two Power Cords in one socket-outlet.

## SPECIFICATIONS

Product Dimensions	596(W) x 630(D) x 998(H) mm
Net Weight	74kg
Power Source	230V, 50Hz AC
Water Quantity (WASH)	68Ltr / Cycle (Max.)
Power Consumption (Heat)	1800 W
Required Water Pressure	0.03 MPa ~ 0.8 MPa (0.3 kgf/cm <sup>2</sup> ~ 8 kgf/cm <sup>2</sup> )

## AUTHORISED SERVICE CENTERS

### Branch Network

#### NORTH ZONE

DELHI: 011-39996369 GURGAON: 0124-4201250/54 CHANDIGARH: 0172-5074588

JAIPUR: 0141-4085010 KARNAL: 9254304822 LUDHIANA: 0161 5032738/39/740/741

AGRA: 0562-3201515 LUCKNOW: 0522-4017315 DEHRADUN: 0135-3248805

JODHPUR: 0141-3268934, 3248934 JALANDHAR: 0181-5020297 VARANASI: 0542-2363383

JAMMU: 0191-2431759 GHAZIABAD: 0120-4162000

#### SOUTH ZONE

CHENNAI: 044-26209378/2629379 BANGALORE: 080-32941177/66/44

COCHIN: 0484-3113155/66/77 HYDERABAD: 040-32449623, 32446200

COIMBATORE: 0422-2333146 MADURAI: 0452-3268866/27 VIJAYAWADA: 0866-3248833/55

VIZAG: 0891-2732037 HUBLI: 0836-3246644/55, 4250971

MANGALORE: 0824-2491388 CALICUT: 0495 - 3233511/22 WARANGAL: 0870- 3293300/11

#### EAST ZONE

KOLKATA: 033-44031400 BHUBANESHWAR: 0674-2597281 RANCHI: 0651-2340362

ASANSOL: 0341-2221017 GUWAHATI: 9954746944 PATNA: 0612-6457897

#### WEST ZONE

AHMEDABAD: 079-26400418/26408976 AURANGABAD: 0240-2471201

BHOPAL: 0755-3206631 BARODA: 0265-2359084/3249443 SURAT: 0261-2461569

RAJKOT: 0281-2465041 GOA: 0832-2462554 RAIPUR: 0771-2445196 THANE: 022-32162709

PUNE: 020-24260329/489 INDORE: 0731-2544537 MUMBAI: 022-40584600

NAGPUR-AKOLA: 0712-2543079 JABALPUR: 0761-3221556 NASHIK: 0253-2582703/704

# WARRANTY TERMS AND CONDITIONS

## FILL AND DESPATCH WARRANTY CARD ELSE THE WARRANTY VOIDS

VIDEOCON warrants to the purchaser of this Videocon Washing Machine that for a period of 24 months, commencing from the date of purchase, the company will repair or replace free of charge any part or parts of the Washing Machine except Top Lids, Inlet/Drain Hose and lint Filter, should the company be fully satisfied, in its sole discretion, that the defect/s is/are due to faulty material or workmanship only. The warranty will be governed by the following clauses :

1. This warranty is confined to the original products of the company only.
2. The company or their authorised service Agent / will repair / replace all parts failing due to faulty material or defective workmanship pertaining to the above Washing Machine.
3. Only the company or its authorised Service Agent / can service/repair/attend to install/reinstall the washing Machine. The list of Company's service centre is as printed overleaf.
4. If the machine is not repairable at the place of its installation then the decision of technician to call back the machine to Service Centre for repairs shall be final. In such cases it is the responsibility of Purchaser to bring the machine to the Service Centre.
5. For the units installed beyond the municipal limits of the jurisdiction of the authorised service a Company's authorized service station or the dealers of VIDEOCON as well as expenses incurred in connection with deputing of service personnel/technicians towards to and fro travel conveyance with deputing of service incidentals etc. will be borne by the customer.
6. Any change of location of the unit and / or change of ownership has to be done in consultation with VIDEOCON or its authorised service agent so that the warranty obligation for the remaining part of the warranty could be transferred to the new owners or the original purchaser but at the new location. The unit so transferred will be inspected by VIDEOCON or its service agent at the cost inspection charges.
7. Any damage caused during shifting will be repaired on chargeable basis. In the event of repair / replacement of any part/s of the set, this warranty will thereafter, continue and remain in force only for the unexpired period as per the warranty card issued at the time of purchase of the set. Moreover, the time taken for repair and in transit, whether under the warranty or otherwise, shall not be excluded from the warranty period.
8. This warranty will continue to be in force for the term herein specified, irrespective of what replaced may be provided under it, and such replacement shall not attract any fresh warranty unless specified.
9. The warranty extended herein is in lieu of all implied conditions and warranties under the law and is confined to the repair or replacement of defective parts and does not cover any consequential or resulting liability, damage or loss arising from such defects. Furthermore, the warranty in no case, shall extend to the payment or any monetary consideration whatsoever of the replacement or return of the Washing Machine as a whole.
10. The defective spare part/s shall be the sole property of company and will be collected by the Authorised Service Centre / Franchisee.
11. It shall be the discretion of the company to replace the required part with suitable and currently available part/s. The company may also use the substitute part for defective part.

# WARRANTY TERMS AND CONDITIONS

12. The warranty does not cover any accessories external to the system or supplied by dealer.
13. The company's obligation under this warranty shall be limited to repairing or providing replacement of parts, which are found to be defective within warranty period.
14. Any defects in electrical installation on fittings outside Washing Machine shall have to be rectified by the purchaser only.
15. The company shall not be liable for any delay in rectifying the machine, in the event of non-availability of components and shall in no way be responsible for any losses, direct or indirect, arising out of the delay, if any.
16. If the machine is inspected by the authorized service center during warranty period and product is found free from any sort of damage/defect, Applicable visiting charges will be payable by customer.
17. Warranty shall stand ceased / cancelled if the machine is used for any type of commercial purpose.
18. The company is not responsible for any breakage or non - performance or delay in providing service due to strike, industrial/labour dispute, fire, accident, damage, restriction imposed by Government, Act of God, riot, war, etc. which are beyond the control of the company.
19. The warranty is issued subject to the jurisdiction of Aurangabad Court of law.
20. If any colored internal or external components are replaced there will be commitment to ensure that shades match with the original or other components. The replaced shades, patterns, tints may vary from the customer's unit due to continuous usage of unit. Any matching components changed at customer's request will be on chargeable basis except the component which are actually needed.

## **THIS WARRANTY IS NOT APPLICABLE IN ANY OF THE FOLLOWING CASES**

1. The warranty card is not duly filled and mailed back to the service centre for registration by the purchaser, within 10 days of purchase.
2. The completed Warranty card is not presented to the company technician at the time of repair.
3. The machine is not used according to the instruction given in owner's guide.
4. Defects caused by improper use as determined by the company personnel.
5. Any repair work/installation is carried out by the person other than Videocon service centre/service agent.
6. Site (premises where the product is kept) conditions that do not conform to the recommended operating conditions of the machine.
7. The serial number is deleted, defaced or altered.
8. If the electrical power supply voltages, are not within the stipulated norms.
9. Any defects arising out of lightning, abnormal voltage, fire, accident, any acts of God or other circumstances beyond the control of the company while the machine is in transit or otherwise.
10. Defects caused by household pets, Rats, Cockroaches or any other animals or insects.

**For any doubts or clarifications please contact us on-**

**TEKCARE INDIA PRIVATE LIMITED.,**

15km. STONE, AURANGABAD-PAITHAN ROAD,

VILLAGE CHITEGAON, TALUKA PAITHAN,

AURANGABAD - 431 105,

MAHARASHTRA, INDIA.

PHONE No. - 02431 - 329271,329783

E MAIL : [customercare@vgmail.in](mailto:customercare@vgmail.in)

Web : [www.servicedelight.com](http://www.servicedelight.com)

**CUSTOMER COPY**

Customer Name : _____ Customer Address : _____ _____	Service Registration at - _____ _____
Tel No. : _____ _____	
Dealer Name : _____ Dealer Address : _____ _____	Dealer Bill Date : _____ Bill No. : _____ Set Serial No. : _____
Tel No. : _____ Model No. : _____ DOP : _____	
I accept the terms and conditions of warranty.	
Dealer sign & seal	Customer sign

CUT HERE

**SERVICE CENTER COPY**

Customer Name : _____ Customer Address : _____ _____	Service Registration at - _____ _____
Tel No. : _____ _____	
Dealer Name : _____ Dealer Address : _____ _____	Dealer Bill Date : _____ Bill No. : _____ Set Serial No. : _____
Tel No. : _____ Model No. : _____ DOP : _____	
I accept the terms and conditions of warranty.	
Dealer sign & seal	Customer sign

CUT HERE

**CSO AURANGABAD COPY**

Customer Name : _____ Customer Address : _____ _____	Service Registration at - _____ _____
Tel No. : _____ _____	
Dealer Name : _____ Dealer Address : _____ _____	Dealer Bill Date : _____ Bill No. : _____ Set Serial No. : _____
Tel No. : _____ Model No. : _____ DOP : _____	
I accept the terms and conditions of warranty.	
Dealer sign & seal	Customer sign
This card stands null and void if the Service Center copy of Warranty Card is not dispatched within 10 days of date of purchase (DOP) and duly signed by Authorized Dealer on date of purchase.	

Note : The after sale service shall be subject to the production of this card at the time of each servicing, either at the place of the customer or at any service center. In absence of this card, the company shall not be liable to provide after sale service as per the warranty norms.

**SERVICE**

**1800 419 40 40**  
Landline/Mobile-Toll Free

**39 40 40 40**  
Prefix the STD code of the state capital  
**SMS - 'SVC' to 53030**

**Keeping products Eco-Fit**

IN CASE OF CONSUMER COMPLAINTS, PLEASE CONTACT :  
M/s TEKCARE INDIA PRIVATE LIMITED, 15 Km STONE, AURANGABAD  
PAITHAN ROAD, VILLAGE CHITEGAON, TALUKA PAITHAN,  
DIST-AURANGABAD. - 431105, MAHARASHTRA, INDIA. PH. NO.(02431) 329271,329783  
E-MAIL: customercare@vgmail.in, WEBSITE: www.servicedelight.com  
GET REGISTERED BY SENDING SMS -'SVC' TO 53030

**BUSINESS REPLY CARD**

To,

\_\_\_\_\_

\_\_\_\_\_

\_\_\_\_\_

AFFIX  
PROPER  
POSTAGE  
HERE

**BUSINESS REPLY CARD**

To,

**M/s. TEKCARE INDIA PRIVATE LIMITED.,**  
15km. STONE, AURANGABAD-PAITHAN ROAD,  
VILLAGE CHITEGAON, TALUKA PAITHAN,  
AURANGABAD - 431 105,  
MAHARASHTRA, INDIA.  
PHONE No. : (02431) - 329271,329783

AFFIX  
PROPER  
POSTAGE  
HERE